

*Ein Werkstoff der Natur*



[www.grabholz.de](http://www.grabholz.de)

## *Ein Werkstoff der Natur*



*Das Grab ist die äußere Verbindung  
zu unseren Verstorbenen.  
Die Gestaltung soll dem Charakter  
dieser Verbindung Ausdruck geben.*





Peter Dihrik & Joachim Enderle

## *Ein Werkstoff der Natur*

### **Holz, als Grabmal,**

lange in Vergessenheit geraten und heute oft nur als Kreuze auf unseren Friedhöfen sichtbar. Ein von der Natur gegebenes Material, das beispiellos Wärme, Natürlichkeit und Harmonie ausstrahlt und mit Begriffen wie Heimat, Ruhe und Frieden, Stärke und auch Vergänglichkeit verbunden wird.

All das hat uns vor über 10 Jahren dazu bewegt Grabmale aus Holz zu fertigen. Im Süden Deutschlands am Bodensee fertigen wir nach handwerklicher Tradition Grabmale aus Eichenholz - das „Grabholz“. Eine spezielle Fertigungstechnik, unsere geprüfte Mehrfach-Oberflächenbehandlung sowie das zertifizierte betonfreie Befestigungssystem sorgen für Schutz und Stabilität über Jahrzehnte und machen das Grabholz sicher und beständig.

Mit der Verwendung von Eichenholz und Radiata-Kiefer aus bewirtschafteten europäischen Wäldern und den hierdurch gegebenen kurzen Transportwegen folgen wir den ökologischen Grundgedanken der Nachhaltigkeit und der Ressourcenschonung.

Vielleicht sind es die oben genannten Punkte, die Sie zu uns geführt haben. Oder es ist einfach der Wunsch nach einem individuellen und Natürlichkeit ausstrahlenden Grabmal. Mit einem Grabholz entscheiden Sie sich immer für eine harmonische und besondere Verbindung.

# Ein Werkstoff der Natur



01 Allgäu



02 Allgäu



03 Allgäu



04 Buch



05 Buch



06 Allgäu



07 Allgäu



08 Hotzenwald

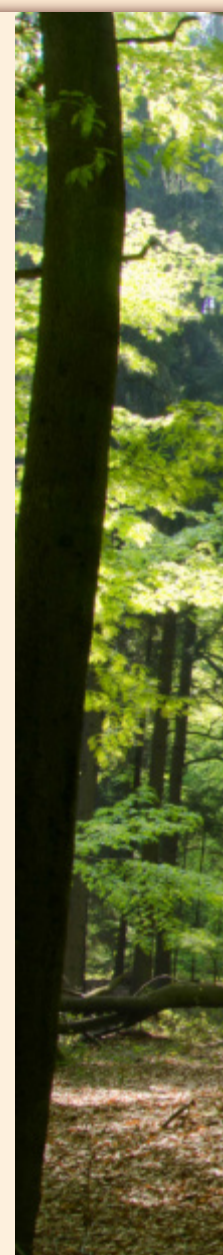





09 Hegau



13 Hegau



10 Allgäu



12 Linzgau



14 Chiemgau



15 Hegau



11 Chiemgau



16 Hegau

# Ein Werkstoff der Natur



17 Hegau



18 Schwarzwald



19 Fichtel



20 Hegau



21 Schwarzwald



22 Schwarzwald



23 Schwarzwald



24 Westerwald



25 Westerwald



26 Westerwald

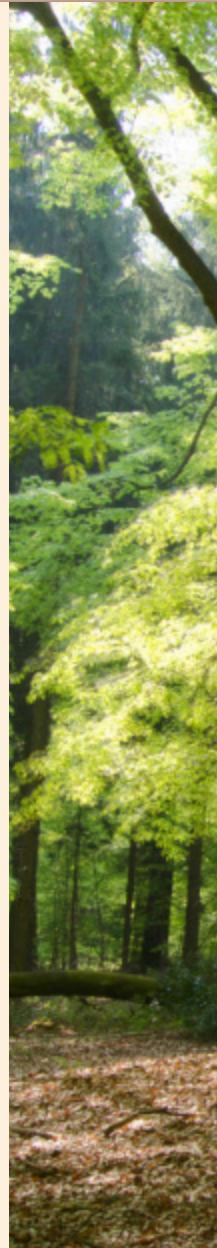





27 Fichtel



28 Fichtel



29 Fichtel



30 Fichtel



31 Fichtel



32 Fichtel



33 Fichtel



34 Fichtel



35 Fichtel

# Ein Werkstoff der Natur



36 Fichtel



37 Fichtel



38 Fichtel



39 Fichtel



40 Fichtel



41 Fichtel



42 Fichtel



43 Fichtel

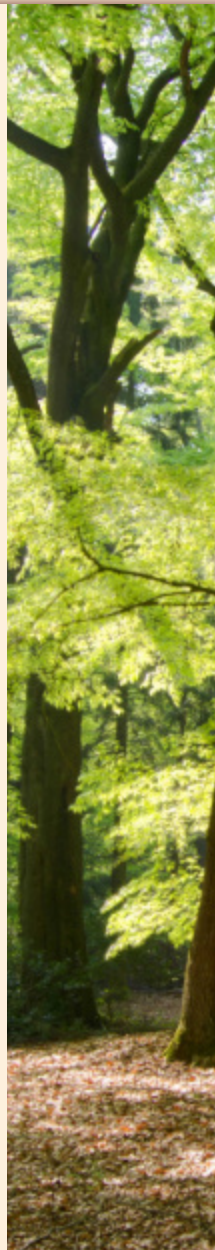





44 Havel



45 Havel



46 Altmühl



47 Altmühl



48 Altmühl



51 Altmühl



49 Havel



50 Havel

# Ein Werkstoff der Natur



52 Holstein



55 Altmark



53 Holstein



54 Holstein



56 Wendland



57 Wendland



58 Wendland



59 Altmark

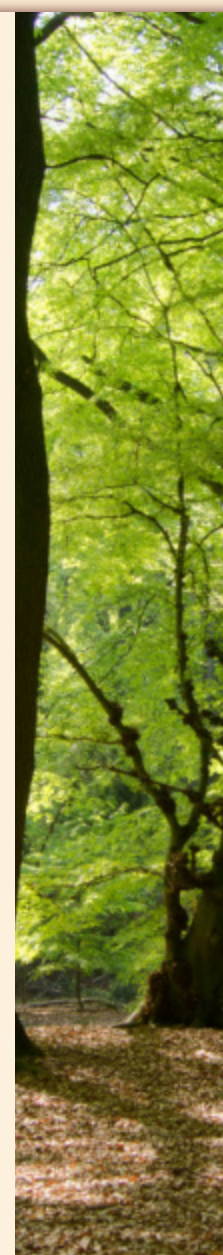





60 Odenwald



62 Taunus



61 Odenwald



63 Pfalz



64 Eifel



65 Odenwald



66 Taunus



67 Taunus



# Ein Werkstoff der Natur



68 Kreuz



69 Kreuz



70 Kreuz



71 Kreuz



72 Feldkreuz



73 Kreuz

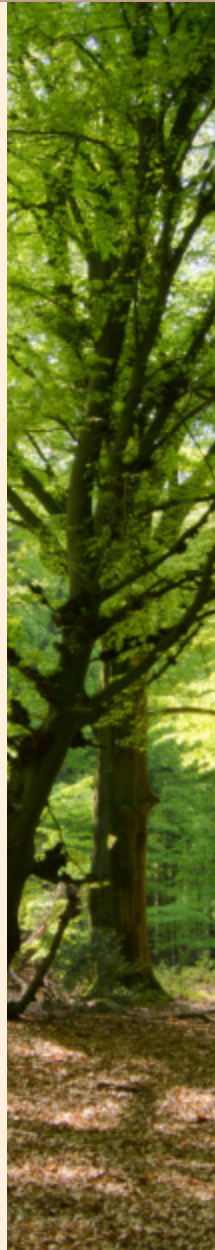





74 Segelschiff



75 Sondermodell

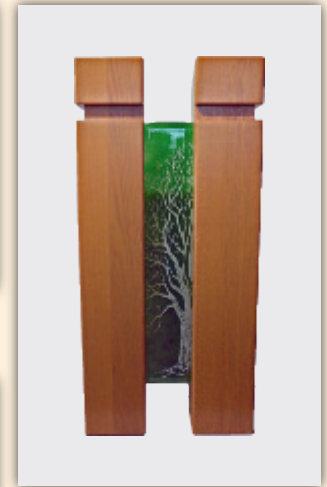

76 Altmark



77 Sondermodell



78 Sondermodell



79 Rhön



80 Sondermodell



81 Soonwald

# Ein Werkstoff der Natur



1 Julia



2 Luna



3 Luna



4 Ronja



5 Benni



6 Luna



7 Ronja

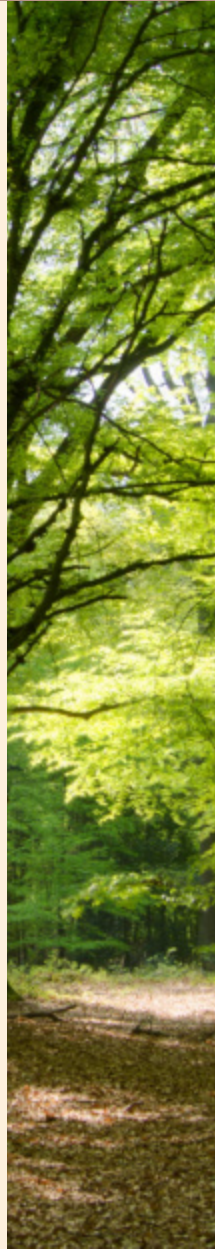



## Holzarten / Verarbeitung von Hölzern



■ Sandwichverleimung

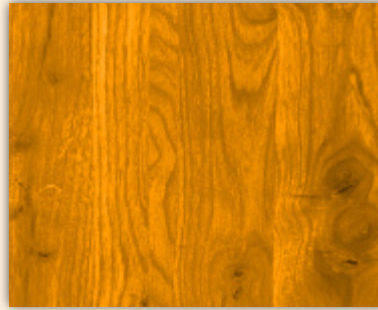

■ Eiche Rustikal



■ Eiche Natur

### Optional bieten wir Ihnen:

Endbehandelte Oberflächen in verschiedenen Varianten.  
Diese können zusätzlich gebürstet oder behauen werden.

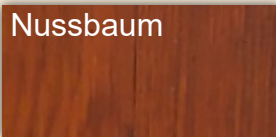

Nussbaum

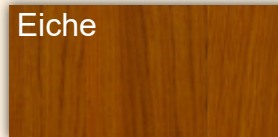

Eiche

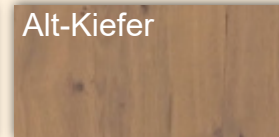

Alt-Kiefer

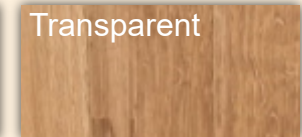

Transparent

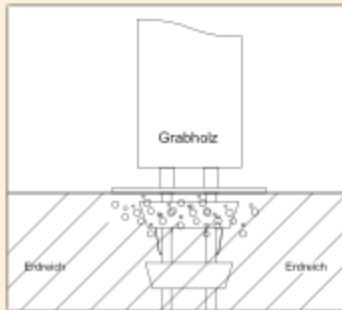

■ Pfahlgründung / Erdfix

### Fundament - freie Montage

Durch unseren Gebrauchsmustergeschützten Erdfix kann die Fixierung des Grabholzes absolut sicher und ohne Hilfsmittel wie z.B. Beton gewährleistet werden (DEKRA geprüfte Standsicherheit). Dadurch kann das Grabmal deutlich früher gesetzt werden. Der Erdfix ist mehrmals einsetzbar und ohne Rückstände wieder entfernbar. Eine Ausrichtung der Neigung nach allen Seiten ist gewährleistet.

(Bei vorhandenen Streifenfundamenten kommt eine Variante des Erdfix zum Einsatz)

# Ein Werkstoff der Natur

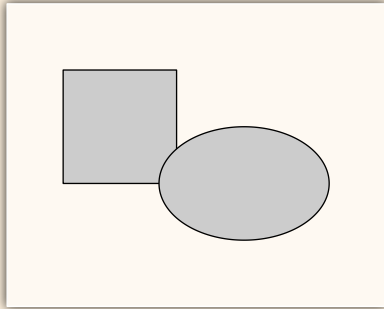

■ Allgäu (Pult)

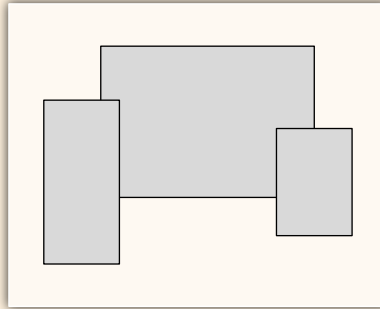

■ Hegau

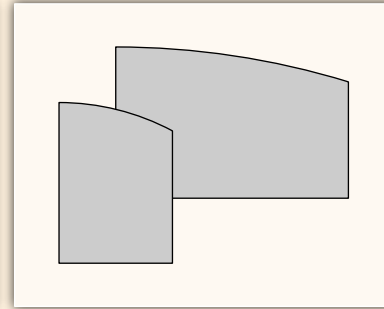

■ Linzgau

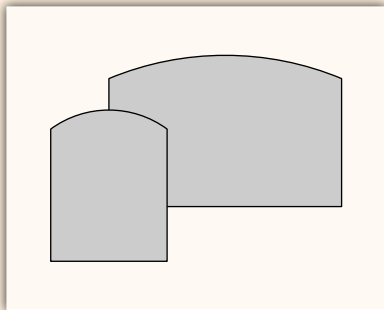

■ Allgäu

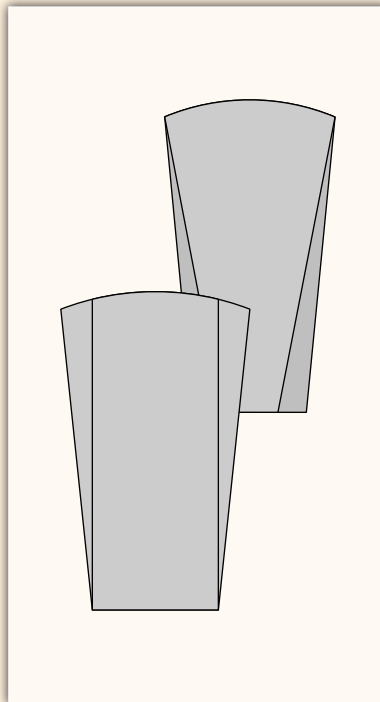

■ Chiemgau

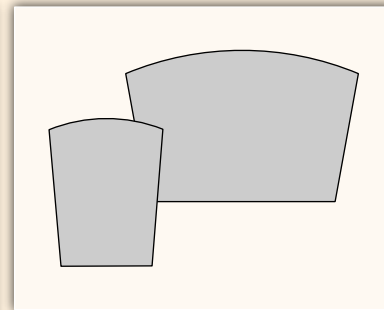

■ Chiemgau

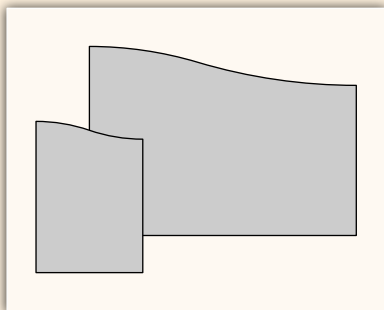

■ Schwarzwald

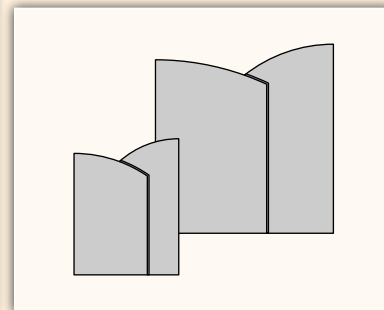

■ Schwarzwald

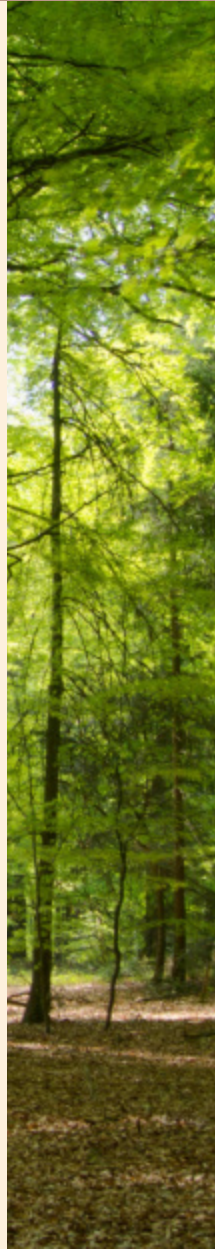



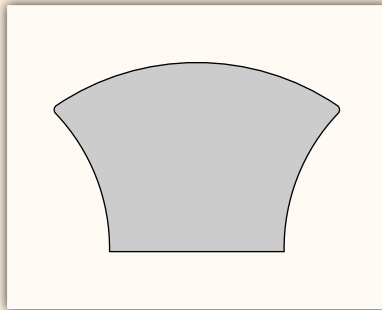

■ Harz

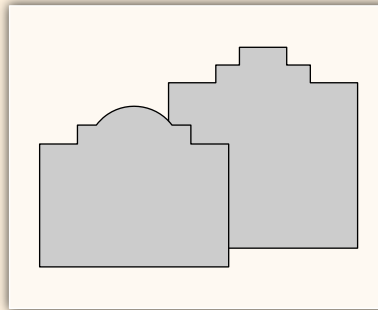

■ Westerwald

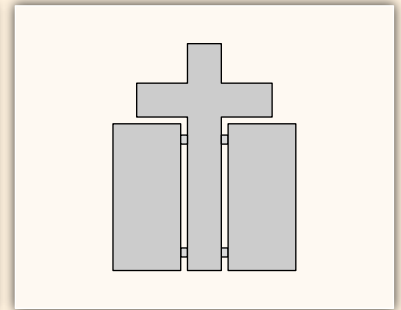

■ Westerwald

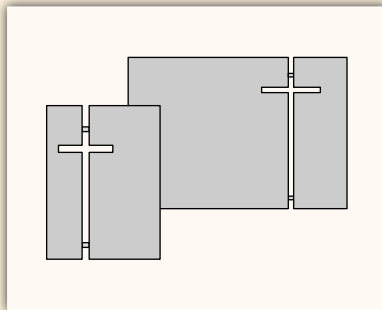

■ Fichtel

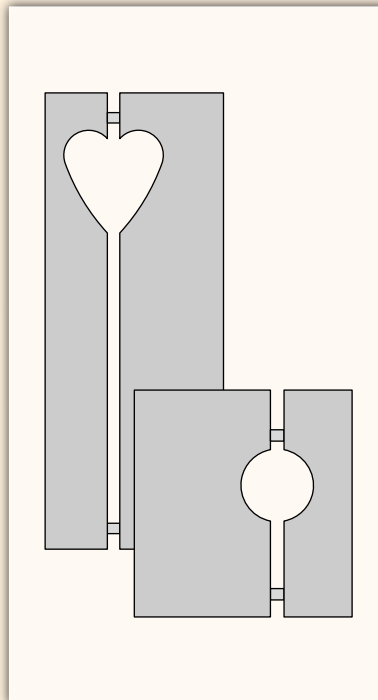

■ Fichtel

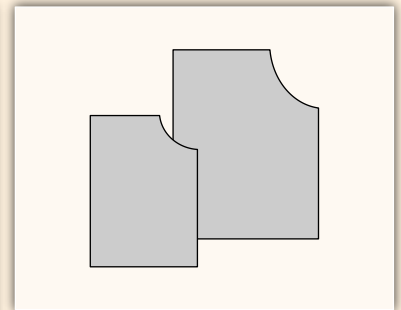

■ Friesland

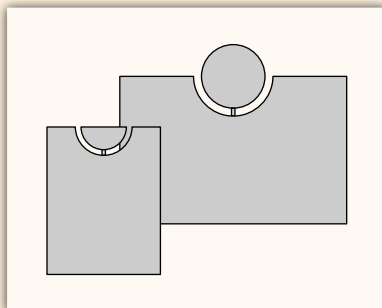

■ Havel

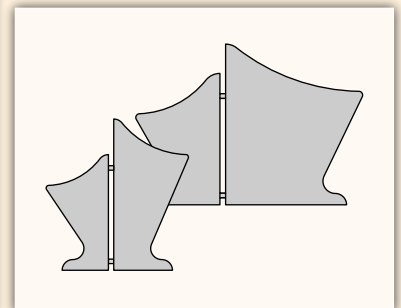

■ Heide

# Ein Werkstoff der Natur

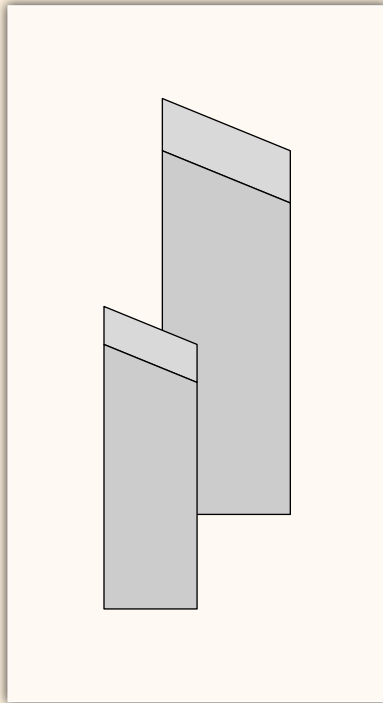

■ Altmühl

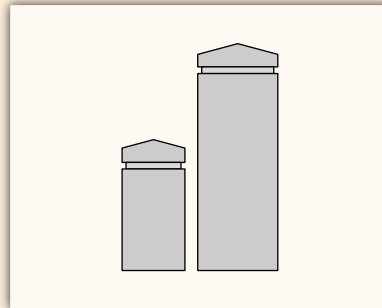

■ Soonwald

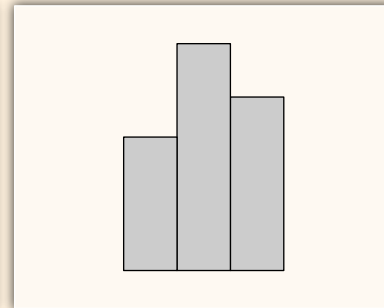

■ Holstein

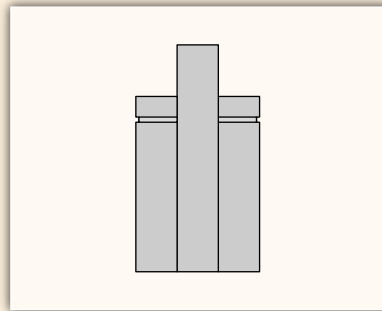

■ Holstein

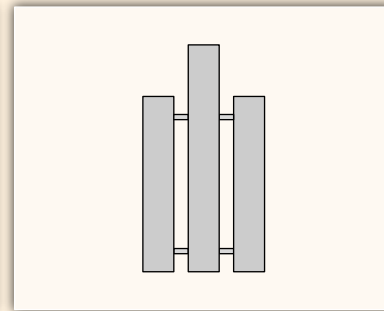

■ Holstein

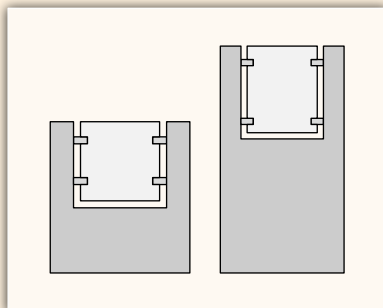

■ Wendland

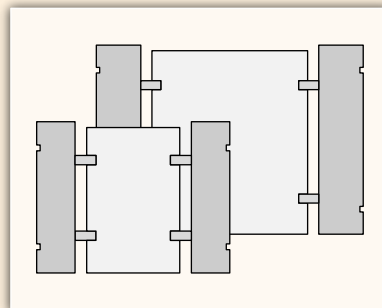

■ Altmark

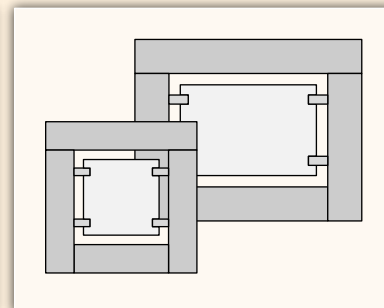

■ Odenwald

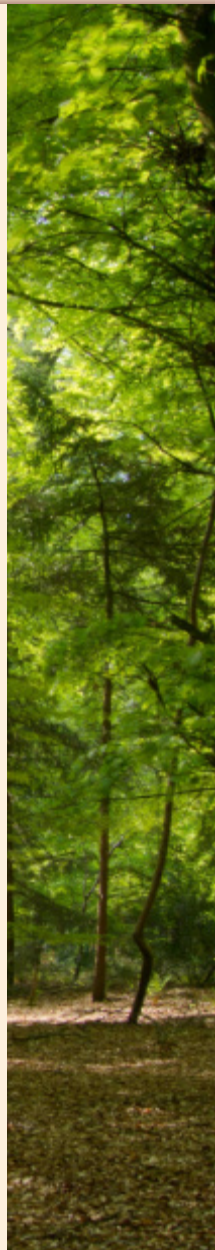



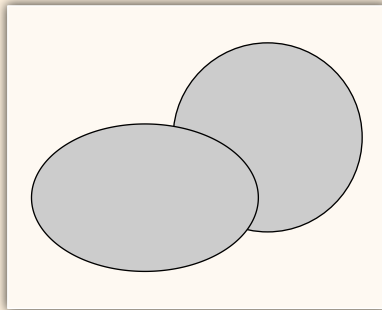

■ Hotzenwald

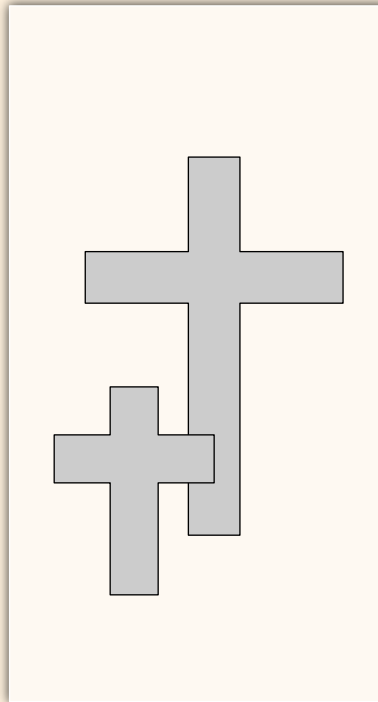

■ Kreuz

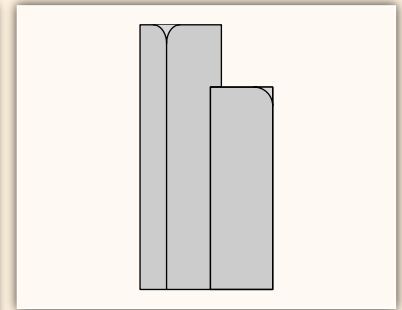

■ Pfalz

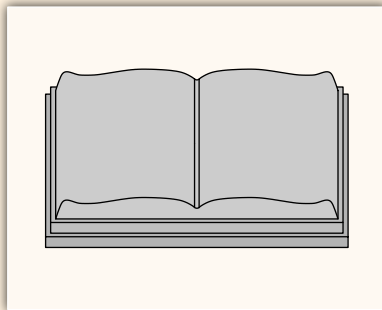

■ Buch

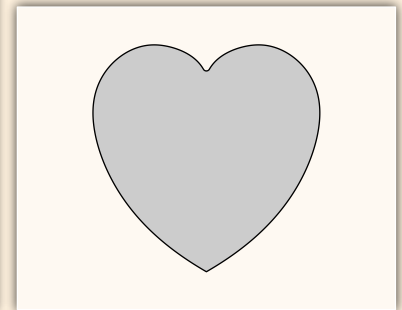

■ Herz

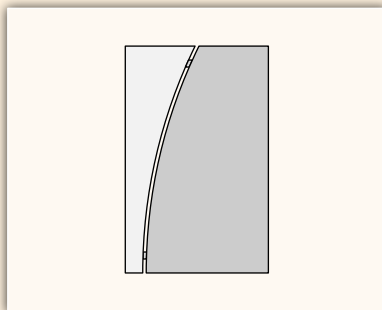

■ Taunus

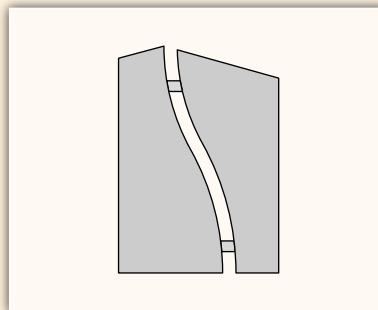

■ Eifel

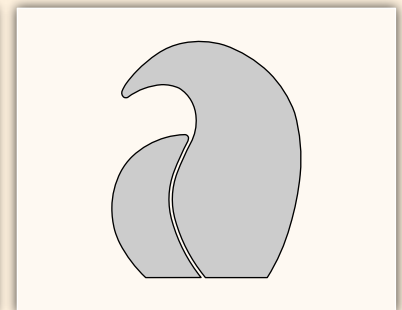

■ Rhön



## Grabeinfassungen nach Wunsch



### ■ Erdabdeckung

Erdabdeckungen können das Gesamtbild verschönern und verhindern das Wachstum von Unkraut und Pflanzen



### ■ Einfassung Holz

Grabeinfassung in Eichenholz  
(Die Haltbarkeit ist auf max. 10 Jahre anzusetzen)

oder Radiata Kiefer  
(Die Haltbarkeit ist auf 10 bis 20 Jahre anzusetzen)



### ■ Einfassung Stein

Grabeinfassung in Granit

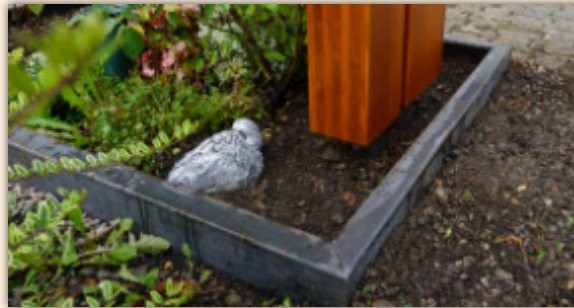

### ■ Einfassung Stahl

Grabeinfassung in Cortenstahl





## Verwendete Steine:

Wir verwenden ausschließlich Europäisches Material, und bevorzugen regionale Steine



■ Calanca Gneis



■ Cresciano Gneis



■ Tarn Granit



■ Dorfer Grün Quarzit

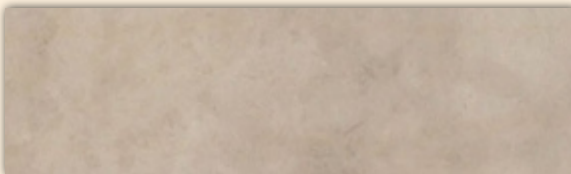

■ Ocean Beige Kalkstein



■ Odenwälder Sandstein

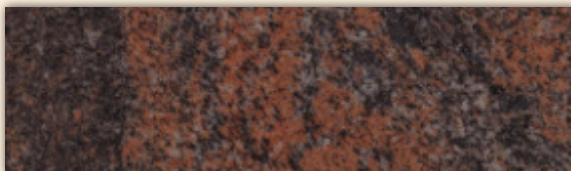

■ Barap Granit

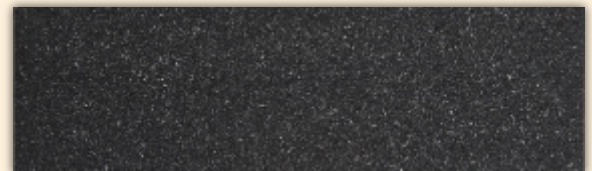

■ Schwedisch Schwarz Granit



# Ein Werkstoff der Natur



E01



E02



E05



E03



E04



E08



E09



E10





E06

E07

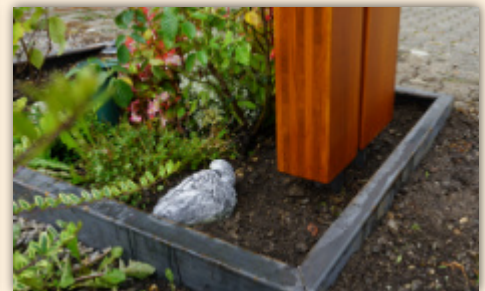

E11

E12

E13

# Ein Werkstoff der Natur



■ Weizen



■ Blume



■ Orchidee



■ Rose



■ Baum



■ Laubbaum Groß



■ Efeu



■ Auto ( Käfer )



■ Pusteblume

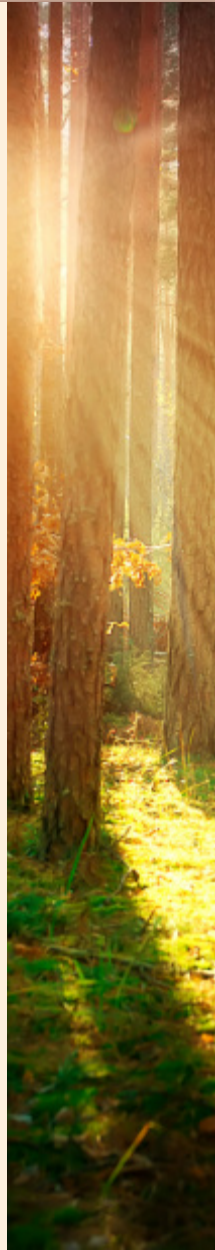





■ Segelboot

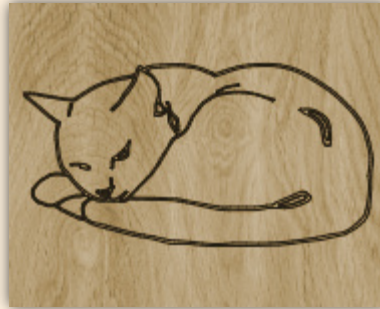

■ Katze



■ Noten



■ Schmetterling



■ Betende Hände



■ Klarinette



■ Sonnenblume



■ Eichenzweig



■ Schilf

## Verschiedene Gestaltungsmöglichkeiten für Ihr Grabholz:

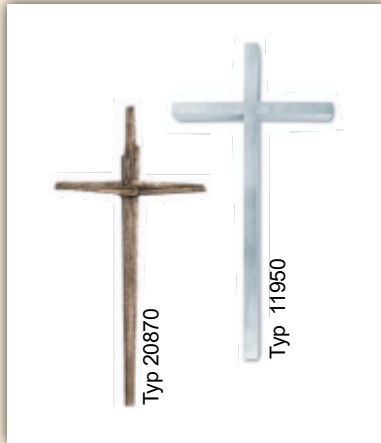

■ Kreuzformen



■ Schrift gefräst, Edelstahlschriftzug, Bezeichnungen



■ Glasplatte satiniert



■ Kundenwünsche



■ Schrift 10036 Bernd  
In Aluminium und Bronze

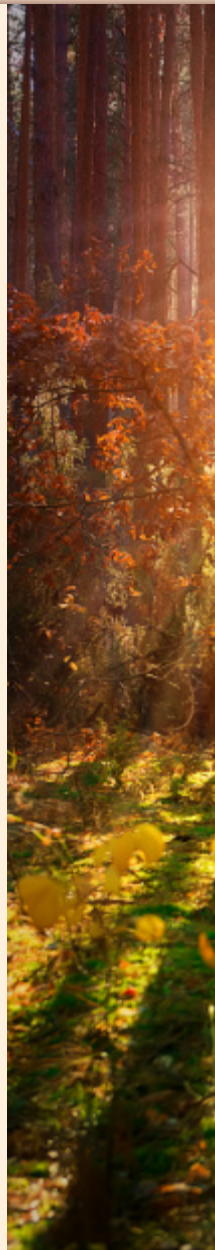



## Urnen – Hochgrab

Unser Urnenhochgrab ist auf kleinen Flächen einsetzbar. Die erhöhte Position ermöglicht eine leichte Bepflanzung und Reinigung der Flächen. Dadurch ist es ideal geeignet für Menschen mit körperlichen Einschränkungen. Zusätzlich sind die Flächen teilweise mit Rollatoren unterfahrbar.



### ■ Urnen- Gemeinschafts- Grabanlage



Das Hochgrab bietet genug Fläche für 10 Urnen, bzw. 20 Urnen als Paargrab.  
Die Fläche misst etwa 2,7 m x 1,3 m bei einer Höhe von 0,9 m



## Ergänzungen für Grabhölzer

Nachbeschriftungen sind jederzeit bei allen Modellen möglich.  
Bei nachfolgenden Ergänzungen wird das Grabholz von uns abgeholt, bearbeitet und wieder aufgestellt

## Pflegehinweise für das Grabholz

Zum Schutz vor Witterungseinflüssen ist das Grabholz mit einer speziellen Mehrfach-Oberflächenbehandlung versehen. Diese bietet bei ca. 2x im Jahr erfolgreicher Reinigung mit Wasser einen langjährigen dauerhaften Schutz. So wird die Bildung von Flechten oder Moosen verhindert.  
Generell gilt: Alles was der Witterung und der Umwelt ausgesetzt wird, benötigt für dauerhafte Haltbarkeit ein wenig Pflege.



Sie erhalten für das Grabholz ein Pflegeset, welches einen Reiniger und eine klare Pflegemilch enthält. Wir empfehlen jährlich im Frühjahr und im Herbst diese aufzutragen. Ihr Grabholz erhält damit immer wieder einen Schutzfilm, der die Oberfläche pflegt und resistent gegen Schmutz und UV-Strahlung macht.

Weitere Informationen zur Pflege erhalten Sie auf unserer Homepage:  
[www.grabholz.de](http://www.grabholz.de), gerne auch durch eine kurze persönliche Beratung.





### Was tun wir für Sie?

Unsere Aufgabe sehen wir darin, das umzusetzen, was Sie sich vorstellen

- Umfassende Beratung
- Ausarbeitung und zeichnerische Darstellung von Sonderwünschen
- Einholen von Genehmigungen bei den Friedhofsverwaltungen
- Aufbau und Montage des Grabholzes
- Wenn gewünscht Vermittlung eines Pflegeservices



### Was kostet ein Grabholz?

Da verschiedene Ausführungstypen, unterschiedliche Größen sowie Beschriftungen und Ornamente zur Auswahl stehen, hier zur Orientierung einige Anhaltspunkte:

Ab 856,- inkl. MwSt. (Typ Allgäu/Liegegrabholz rustikal zzgl. Beschriftung)  
 Bis 4872,- inkl. MwSt. (Typ Westerwald natur/rustikal zzgl. Beschriftung)

Die oben genannten Preise beziehen sich auf Grabholz Standard Modelle.



### Unsere Herzensangelegenheit!

Die Grabholz GmbH unterstützt **Xertifix**.

**Xertifix e.V.** mit Sitz in Freiburg hat es sich seit 1990 zur Aufgabe gemacht, gegen Kinderarbeit in den Steinbrüchen von Indien vorzugehen.

Weitere Informationen unter: [www.xertifix.de](http://www.xertifix.de)

# Ein Werkstoff der Natur

<b>Nr.</b>	<b>Modell</b>	<b>Nr.</b>	<b>Modell</b>
01	Allgäu U 01012	23	Schwarzwald E 05023 mit Regenbogen
02	Allgäu U 01012	24	Westerwald D 07052
03	Allgäu Sondermodell	25	Westerwald D 07053
04	Buch E 21011	26	Westerwald D 07052 Sonder.
05	Buch E 21011	27	Fichtel D 08012 mit Kreuz
06	Allgäu Ellipse U 01013	28	Fichtel D 08012 Sonder.
07	Allgäu Ellipse U 01013	29	Fichtel D 08013
08	Hotzenwald E 18011 Rund	30	Fichtel D 08031
09	Hegau D 01012 mit Nut	31	Fichtel E 08013
10	Allgäu D 03012 mit Herz Sonder.	32	Fichtel E 08022
11	Chiemgau E 04041	33	Fichtel E 08021
12	Linzgau D 02012 Sonder.	34	Fichtel E 08033
13	Hegau E 01015 mit Herz, Kernholz	35	Fichtel E 08032 Sonder
14	Chiemgau E 04031	36	Fichtel D 08021
15	Hegau E 01013 mit Sonderfräsungen	37	Fichtel E 08013 Sonder.
16	Hegau E 01015 mit Herz	38	Fichtel D 08012 Sonder.
17	Hegau E 01015 mit Kernholz	39	Fichtel E 08013
18	Schwarzwald E 05012	40	Fichtel E 08043 Sandstein
19	Fichtel D 08012 mit Kreuz Sonder.	41	Fichtel D 08031 Sonder.
20	Hegau E 01014 Sonder.	42	Fichtel E 08013 Sonder.
21	Schwarzwald E 05023	43	Fichtel E 08023 Sonder.
22	Schwarzwald D 05022	44	Havel E 10012 Steinweg Sonder.



Nr.	Modell	Nr.	Modell
45	Havel D 10032 Sonder.	67	Taunus E-23013 Kalkstein
46	Altmühl S 12012	68	Kreuz D 19012 mit Dach
47	Altmühl doppel	69	Kreuz E 19012 Sonder.
48	Altmühl doppel	70	Kreuz E 19012
49	Havel E 10033	71	Kreuz D 19012 mit Dach Sonder.
50	Havel E 10013	72	Feldkreuz
51	Altmühl S 12011	73	Kreuz E 19012
52	Holstein E 14032 Sonder.	74	Segelschiff mit Sandstein Sonder.
53	Holstein Kernholz Sonder.	75	Kundenwunsch Sonder.
54	Holstein E 14021 Sonder.	76	Altmark E 16023
55	Altmark D 16012 Glas Sonder.	77	Kundenwunsch Sonder.
56	Wendland D 15013 Sonder.	78	Kundenwunsch Sonder.
57	Wendland E 15012 Schriftplatte zweifarbig	79	Rhön E 25022
58	Wendland D 15013	80	Kundenwunsch Sonder.
59	Altmark D16013	81	Soonwald S 13012 Maria
60	Odenwald D 17014 Sonder.	1	<b>Sternenkind</b> Julia
61	Odenwald E 17011	2	<b>Sternenkind</b> Luna Stern weiß
62	Taunus E-23012 Sandstein gesprengt	3	<b>Sternenkind</b> Luna Sonne
63	Pfalz E 20013	4	<b>Sternenkind</b> Ronja Kreuz
64	Eifel E-24022	5	<b>Sternenkind</b> Benni
65	Odenwald D 17012	6	<b>Sternenkind</b> Luna Meer
66	Taunus E 23012 Kalkstein gesprengt	7	<b>Sternenkind</b> Ronja Engel rot



**GRABHOLZ GmbH**  
**Ausstellung :** Kornblumenweg 40  
D - 78244 Gottmadingen  
Tel. +49 (0) 7731 38 10 20  
Fax +49 (0) 7731 38 10 19  
info@grabholz.de  
www.grabholz.de

